

SERIES 3

# FLite scooter

User Guide

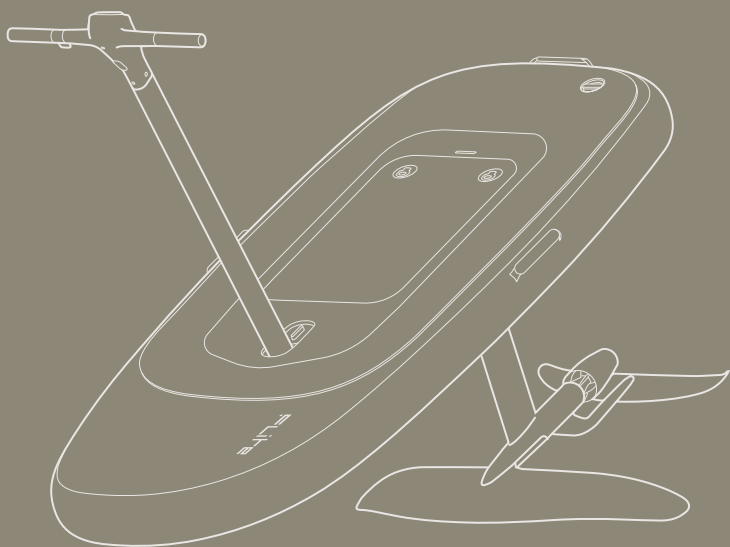





## Important

IN ORDER TO OPERATE THE PRODUCT CORRECTLY AND MINIMISE THE CHANCES OF DAMAGE, SERIOUS INJURY OR DEATH, IT IS ESSENTIAL TO READ AND FOLLOW ALL OF THE INSTRUCTIONS AND WARNINGS IN THE USER GUIDE PRIOR TO ASSEMBLY, SETUP OR USE. BY USING A FLITESCOOTER YOU AGREE THAT YOU DO SO AT YOUR OWN RISK.

CAUTION: THIS PRODUCT HAS BEEN KNOWN TO DRAMATICALLY IMPROVE YOUR LIFE AND HAPPINESS LEVELS.



For the latest version and translations of this guide visit

[fliteboard.com/support](https://fliteboard.com/support)



Watch our video tutorials at

[fliteboard.com/video](https://fliteboard.com/video)



Authorised Flite Service, Resellers and Fliteschools

[fliteboard.com/locations](https://fliteboard.com/locations)



Download the Flite App

[fliteboard.com/app](https://fliteboard.com/app)



Flitescooter support

[fliteboard.com/support](https://fliteboard.com/support)



Flitescooter contact

[fliteboard.com/contact](https://fliteboard.com/contact)



Material Safety Data Sheets

[fliteboard.com/MSDS](https://fliteboard.com/MSDS)



Ready to fly post storage checklist

[fliteboard.com/readytoflychecklist](https://fliteboard.com/readytoflychecklist)



6 Month Flitecell Checklist

[fliteboard.com/flitecellchecklist](https://fliteboard.com/flitecellchecklist)





## Propulsion system

The Flitescooter propulsion system includes a powerful jet.

KEEP BODY, FINGERS AND TOES AWAY FROM FLITESCOOTER'S IMPELLER. CONTACT WITH THE IMPELLER CAN CAUSE SERIOUS INJURY OR DEATH.

NEVER TOUCH THE IMPELLER IN OR OUTSIDE OF THE WATER.

NEVER HANDLE THE IMPELLER WHILE THE FLITECELL IS CONNECTED.

ALWAYS USE THE FLITESCOOTER A SAFE DISTANCE FROM OTHER WATERCRAFT, SWIMMERS, SURFERS, DIVERS AND WILDLIFE.

NEVER USE FLITESCOOTER IN WATER SHALLOWER THAN 1M OR 3.3FT. HITTING THE BOTTOM AT SPEED CAN CAUSE INJURY AND/OR DAMAGE TO FLITESCOOTER.

## Hydrofoil safety

The Flitescooter hydrofoil system comprises a mast (or strut), a main wing and stabiliser wing. These components include sharp trailing edges and wing tips. Take care not to kick or hit the sharp edges when in the water.

FALLING ON THE HYDROFOIL CAN CAUSE SERIOUS INJURY OR DEATH.

WE ALWAYS RECOMMEND YOU WEAR APPROPRIATE SAFETY GEAR WHEN FLITESCOOTERING, INCLUDING AN APPROVED IMPACT VEST / PFD AND HELMET. CHECK YOUR LOCAL REGULATIONS TO CONFIRM IMPACT VEST / PFD AND HELMET REQUIREMENTS. REFER TO THE MANUFACTURER'S DOCUMENTATION ON SAFETY, CARE AND MAINTENANCE GUIDELINES FOR YOUR IMPACT VEST / PFD AND HELMET.

TAKE CARE TO LEARN STEP BY STEP, FOLLOWING THE INSTRUCTIONS IN THIS GUIDE AND THE FLITESCOOTER VIDEO TUTORIALS AT [fliteboard.com/video](https://fliteboard.com/video)

## Learning to Flitescooter

We recommend learning to Flitescooter with an instructor at an authorised Fliteschool. Fliteschool locations can be found at [fliteboard.com/locations](https://fliteboard.com/locations)

PLEASE VIEW OUR HOW TO FLITESCOOTER VIDEO AT [fliteboard.com/video](https://fliteboard.com/video) TO LEARN THE PROPER TECHNIQUE AND REVIEW RIDING SAFETY INFORMATION.

FLITESCOOTER IS DESIGNED FOR USE IN CALM WATER ONLY. IT IS NOT SUITABLE FOR RIDING BREAKING WAVES IN THE SURF ZONE. RIDERS DO SO AT THEIR OWN RISK. FLITESCOOTER SHOULD NEVER BE RIDDEN NEAR OTHER WATER USERS (INCLUDING SWIMMERS AND SURFERS) OR OFFSHORE FROM SWIMMERS AND SURFERS (IN CASE FLITESCOOTER IS PUSHED TOWARDS SHORE IN A WAVE).

FLITESCOOTERING CAN BE EASY WHEN PROPER TECHNIQUE IS APPLIED. INCORRECT TECHNIQUE CAN RESULT IN INJURY OR DAMAGE.

## Important rider safety

### 1 Read the User Guide and watch the How to Flitescooter video

Before attempting to Flitescooter for the first time, read this User Guide and pay special attention to the warnings and disclaimers. Most injuries can be avoided by using proper technique when learning. Watch the How to Flitescooter video at [fliteboard.com/video](http://fliteboard.com/video)



### 2 Wear a helmet and Impact Vest / PFD

Wear an approved and certified helmet and impact vest / PFD (Personal Flotation Device) at all times.

There may be specific rules and legal requirements in your location that also apply.



### 3 Avoid contact with the wings and Flite Jet

Avoid contact with the wings, mast and Flite Jet, which all have sharp edges. Take care to not kick the wings when climbing on to the board.

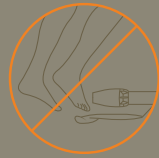

### 4 Keep distance

Keep well clear of other water users at all times. Check regulations for vessel operating distance rules in your area. Always be on the lookout for swimmers, divers, other vessels or obstacles when riding; they may be obscured by waves or glare.

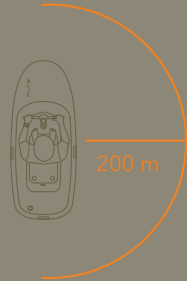

### 5 Release the throttle

Release the thumb throttle immediately on committing yourself to a fall. This will stop the motor and reduce the forces which could otherwise lead to a more extreme crash. Practice this skill when learning with the goal of stopping the motor before you hit the water in a fall.

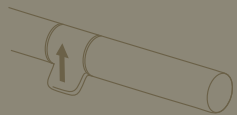



## 6 Wireless safety key



**Model:** WSK1

**Battery:** CR2032 coin battery, 220mAh, 3.0V

**Operating temperature range:** -20 to 60 °C / -4 to 140 °F

**FCC warning:** Any changes or modifications not expressly approved by the party responsible for compliance could void the user's authority to operate the equipment.

This device complies with part 15 of the FCC Rules.

Operation is subject to the following two conditions:

- (1) this device may not cause harmful interference, and
- (2) this device must accept any interference received, including interference that may cause undesired operation.

Note: This equipment has been tested and found to comply with the limits for a Class B digital device, pursuant to part 15 of the FCC Rules. These limits are designed to provide reasonable protection against harmful interference in a residential installation. This equipment generates uses and can radiate radio frequency energy and, if not installed and used in accordance with the instructions, may cause harmful interference to radio communications. However, there is no guarantee that interference will not occur in a particular installation. If this equipment does cause harmful interference to radio or television reception, which can be determined by turning the equipment off and on, the user is encouraged to try to correct the interference by one or more of the following measures:

- Reorient or relocate the receiving antenna.
- Increase the separation between the equipment and receiver.
- Connect the equipment into an outlet on a circuit different from that to which the receiver is connected.
- Consult the dealer or an experienced radio/TV technician for help.

The device has been evaluated to meet general RF exposure requirement. The device can be used in portable exposure condition without restriction.



### WARNING

THE WIRELESS SAFETY KEY CONTAINS A LITHIUM BUTTON / COIN CELL BATTERY

Button/coin cell batteries are hazardous and must be kept out of reach of children at all times, whether the battery is new or used. These batteries can cause severe or fatal injuries in 2 hours or less if swallowed or placed inside any part of the body.

If it is suspected a button/coin cell battery has been swallowed or placed inside any part of the body, seek immediate medical attention or contact your local Poisons Information Centre.

Dispose of used button/coin cell batteries immediately. Place sticky tape around both sides of the battery and dispose in an outside bin, out of reach of children, or recycle safely.



## Warranty

Flitescooter comes with a Limited Warranty which covers defects in materials or workmanship of the product and aligns to relevant consumer laws of the location of purchase. Further details about the Flitescooter Limited Warranty are set out in your Purchase Agreement.

For our Australian customers: Our goods come with guarantees that cannot be excluded under the Australian Consumer Law. You are entitled to a replacement or refund for a major failure and compensation for any other reasonably foreseeable loss or damage. You are also entitled to have the goods repaired or replaced if the goods fail to be of acceptable quality and the failure does not amount to a major failure. Please ensure that you complete the Warranty Registration/Details of Purchase card at the end of this User Guide.

## Maintaining your Warranty

Flitescooter is much more than a surfboard. Similar to any other electric powered vehicle, it needs to be serviced regularly and maintained to ensure good working order and to prevent breakage.

In order to maintain the above warranty, **a mandatory initial 100 hrs / 1 year service of the eFoil is required.**

Only an Authorised Service Partner or Flite HQ can carry out the mandatory initial service, any ongoing yearly / 100 hrs service, warranty repairs and non-warranty repairs. To find your nearest Service Partner, visit [fliteboard.com/locations](https://fliteboard.com/locations)

Flitescooter has been extensively tested with riders weighing up to 120kg / 265lbs. Our specified limit for warranty is 120kg / 265lbs.

## Initial 100 hrs / 1 year service

This is to check seals, oil, overall inspection of the eFoil system, Flitecell health and Flite Controller.

Carefully pack the eFoil and Flite Controller in the original eFoil Travel Bag including foam inserts. Send to an Authorised Service Partner or Flite HQ (whichever is closest). Flitecell, wings, chargers or other accessories are not required and should not be included.

Please refer to our 'Packing your Flitescooter' video and help documentation via [fliteboard.com/support](https://fliteboard.com/support)

**The Flitescooter Limited Warranty is void if your Flitescooter has missed the required service schedule.**

## Repairs

If subjected to damage the Flitescooter core may be repaired by a surfboard repair specialist.

## Shipping compliance

Shipping batteries can be illegal and dangerous if not done in accordance with dangerous goods shipping regulations. Always consult an appropriate specialist before shipping your Flitecell. Refer to the included MSDS regarding shipping your Flitecell by sea.

## What's in the box

You will receive your Flitescooter in four separate shipment packages.

### Box 1 Flitescooter and wings

Within the board bag you will find the Flitescooter core, bladder, pump and hose, handlebars, Cruiser 1800 wing and Flite 500 stabiliser wing. Cruiser 1800 wing comes with a cover, Tef-Gel, Hex Key M6 and associated bolts and Fuselage cover. Flite 500 stabiliser comes with a cover and the required shims can be found in the accessories pouch.

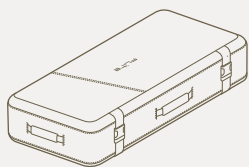

Flitescooter  
travel bag

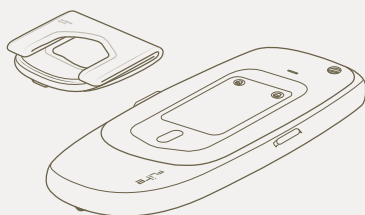

Flitescooter  
bladder

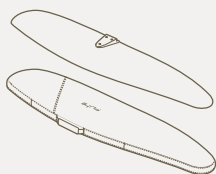

Cruiser 1800  
Fuselage cover 1  
1 x M6 x 40mm  
2 x M6 x 35mm



Flitescooter core

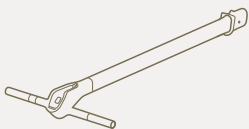

Flitescooter handlebars



Flite 500  
2 x M6 x 25mm

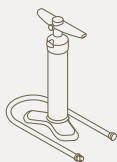

Flitescooter pump  
and hose

## Box 2 Flitecell

Within the included padded Flitecell bag you will find either Flitecell Explore or Flitecell Sport, depending on your choice.

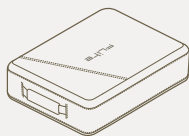

Flitecell  
travel bag

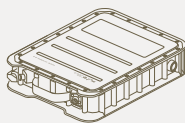

Flitecell  
Explore

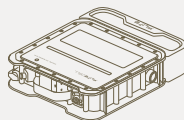

Flitecell Sport  
+ spacer

## Box 3 Flitecell Charger

Within the included Flitecell Charger travel bag, you will find either Flitecell Fast Charger or Flitecell Charger, depending on your choice.

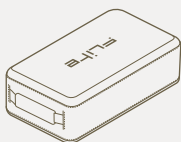

Flitecell Charger  
travel bag

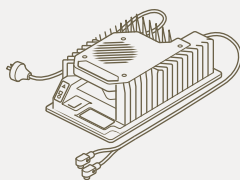

Flitecell Fast  
Charger

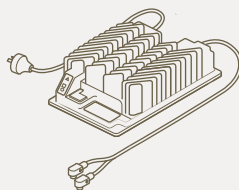

Flitecell  
Charger

## Box 4 Flitescooter eFoil

Within the included travel case you will find the eFoil system.



eFoil travel bag  
eFoil system  
Fuselage tail + O-Ring  
Ring Nut tool  
Shoulder strap  
Accessories pouch

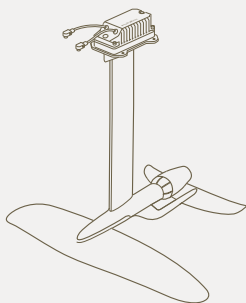

eFoil System Flite Jet  
60cm / 24"

## Box 4 Accessories pouch

Within the included accessories pouch you will find the following components:

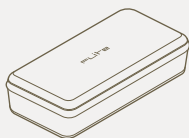

Accessories pouch



Tef-Gel + Brush



Mast Flange Seal + spare

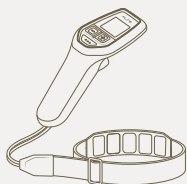

Flite Controller

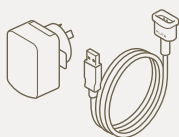

Flite Controller  
USB wall charger  
and charging cable



Stabiliser wing shims  
6 x styles (0-5)



User Guide

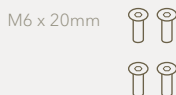

M6 x 20mm  
eFoil Flange bolts



M6 x 16mm  
Tail piece bolt

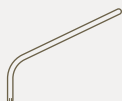

Hex Key M6



Magnetic Clip



Wireless Safety Key

## Getting started

The best way to learn to Flitescooter is to find a Fliteschool in your area. Locate your nearest Fliteschool at [fliteboard.com/fliteschool](http://fliteboard.com/fliteschool)

Watch the Flitescooter video guides at [fliteboard.com/video](http://fliteboard.com/video)

In order to operate the product correctly, avoiding damage or serious injury, it is essential to read and follow all instructions and warnings in the User Guide prior to assembly, setup or use.

FLITESCOOTER IS INTENDED FOR USE WITH THE SUPPLIED FLITE JET, EFOIL AND WINGS ONLY. FLITESCOOTER IS INTENDED FOR USE WITH THE SERIES 2.2 AND LATER FLITE CONTROLLER ONLY.

THE FLITESCOOTER EFOIL IS SET TO SCOOTER MODE AT FACTORY.

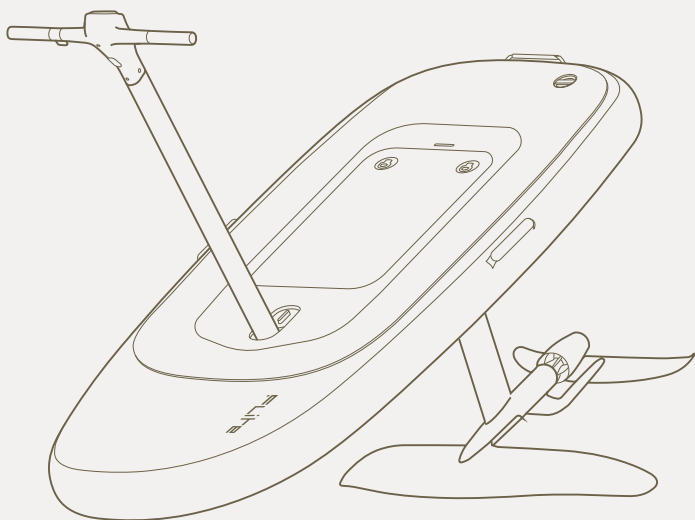



## Charging Flite Controller

- 1 Remove Flite Controller from the accessories pouch or Flitescooter handlebar.
- 2 Remove Flite Controller USB Wall Charger and Charging Cable from the accessories pouch.
- 3 Carefully peel out the rubber cover on the underside of Flite Controller. Attach the magnetic charging plug, ensuring the charging pins are connected.
- 4 Plug in the USB Wall Charger and turn on. When the Flite Controller is charging correctly, the screen will show a charging message. Be careful not to disconnect the magnetic charging plug whilst charging. Always check to ensure the Flite Controller is at least 50% charged before each use.

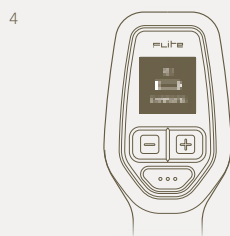
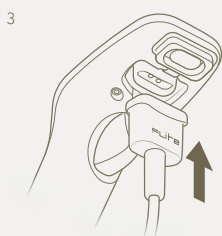
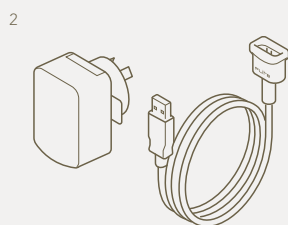

## Flitecell charging procedure

DO NOT COVER THE CHARGER OR INTAKE DURING CHARGING. THE CHARGER SHOULD BE PLACED OUT OF THE REACH OF CHILDREN. CHARGE IN AN INDOOR AREA WITH GOOD VENTILATION AND HEAT DISSIPATION.

DO NOT CHARGE IN HUMID, HIGH TEMPERATURE CONDITIONS. DO NOT CHARGE NEAR FLAMMABLES OR EXPLOSIVES. DO NOT DISASSEMBLE THE CHARGER: THERE IS A DANGER OF HIGH VOLTAGE IN THE CHARGER CASE.

FLITE DOES NOT BEAR ANY RESPONSIBILITY FOR INCORRECT USE OF THE CHARGER. USERS MUST OPERATE THE CHARGER ACCORDING TO THE USER GUIDE.

ALWAYS KEEP THE RED TERMINAL CAPS ON THE FLITECELL WHEN NOT CONNECTED TO THE BOARD/CHARGER.

## Flitecell Fast Charger

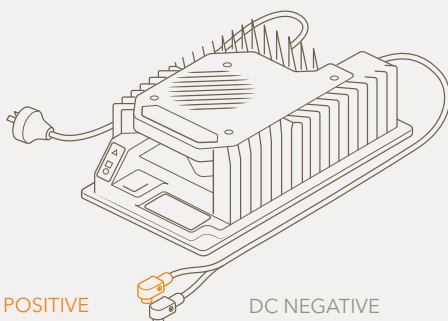

## Flitecell Indicator Guide



Power on



Flashing green

Charging



Solid red

Charger fault

See charger manual



Flashing amber

External error

See charger manual



Flashing green

USB port active

Solid green

Safe to remove USB flash drive

## Charging Flitecell

- 1 Remove Flitecell from its travel bag.
- 2 Place Flitecell in a cool dry location away from flammable or hot items. Safe charging temperatures are 0 - 40°C and optimal charging temperatures are 10 - 30°C.
- 3 Connect Flitecell charger plugs to Flitecell terminals ensuring to connect the orange (positive) connector to the orange terminal first and the black (negative) connector to the black terminal.
- 4 Check that connections have been made correctly. Plug the charger in the wall socket. Place the supplied magnet on the Flitecell for 5 - 10 seconds, as shown by arrow, to activate charging. If the magnet has been misplaced, you can use the base of Flite Controller to initiate charging.
- 5 The charger will automatically turn off when the charging process is complete.

FLITECELL IS A POWERFUL BATTERY CONTAINING A SIGNIFICANT AMOUNT OF ENERGY. CHARGING A DAMAGED FLITECELL CAN RESULT IN A FIRE OR EXPLOSION. ALWAYS INSPECT THE FLITECELL BEFORE CHARGING. CHARGE THE FLITECELL UNDER SUPERVISION, IN A SAFE LOCATION, AWAY FROM DIRECT SUNLIGHT, MOISTURE AND AWAY FROM FLAMMABLE OBJECTS AND SURFACES.

THE BATTERY MANAGEMENT SYSTEM (BMS) BALANCES AND OPTIMISES FLITECELL DURING EACH CHARGE CYCLE.



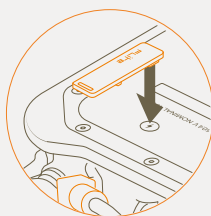
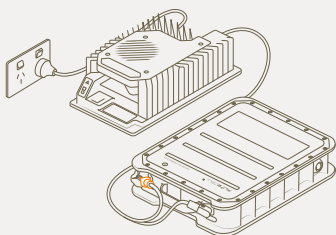

IT IS RECOMMENDED TO DISCONNECT THE FLITECELL AFTER A FULL CHARGING CYCLE.



MAGNET PLACED TO ACTIVATE CHARGING

### Flitecell light

### Light meaning

	Red light flashes Red light on	Capacity 0% - 10% Capacity 10% - 20%
	Green light on Green light flashing	Capacity is 20% - 35% Capacity 20% - 35% + charging
	Two green lights on One on + one flashes	Capacity 35% - 65% Capacity 35% - 65% + charging
	Three green lights on Two on + one flashes	Capacity 65% - 100% Capacity 65% - 100% + charging

## Flitescooter assembly

Fitting the Flitescooter bladder to the core requires proper technique as the fitment between the two are tight for maximum strength. We recommend doing this process with two people, at least the first few times.

- 1 Place the rigid core (Flitebox cavity side up) on a flat, smooth surface to avoid scratching the carbon finish on the core.
- 2 Unroll Flitescooter bladder face down.
- 3 Slide bladder onto core from front end first, maintaining the bladder flap above the core.

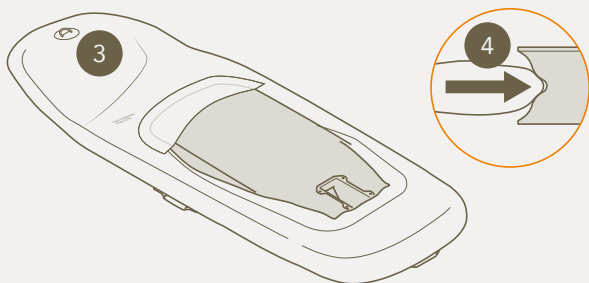

- 4 Ensure bladder is well tucked into the recess along the front edge of the core.
- 5 Carefully stretch bladder over one rear corner first.

NOTE THAT THE REAR UNDERSIDE EDGES OF THE CORE ARE DELIBERATELY SHORTER THAN THE TOP FACE TO MAKE FITMENT OF THE BLADDER EASIER. WARM MILD SOAPY WATER SOLUTION MAY BE APPLIED TO THE FLITESCOOTER BLADDER TO ASSIST WITH FITMENT AND EASE OF ALIGNMENT. RINSE OFF SOAP SOLUTION WITH FRESH WATER AFTER FITMENT IS COMPLETE.

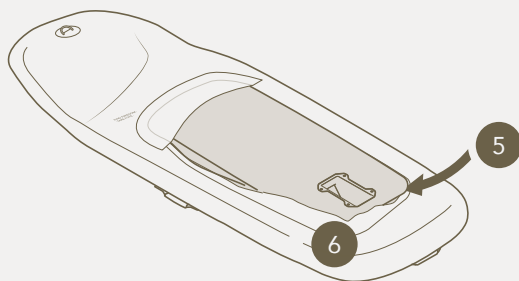

- 6 To stretch bladder over the other rear corner, you will likely need two people. While one person pulls on the bladder, the other person can tap the bladder down with the palm of their hand to get it over the core and into place. If you don't have a second person to assist with fitting the bladder, you could carefully place your foot in the Flitebox cavity to get leverage for stretching it over the final rear corner.
- 7 Be careful that the bladder is positioned evenly and not creased or caught. Check bladder is seated correctly around the core before carefully flipping the Flitescooter over.

DO NOT USE ANY OBJECTS TO GET LEVERAGE FOR FITTING THE FINAL REAR CORNER AS IT COULD DAMAGE THE CORE. PLACE ON A SMOOTH, SOFT SURFACE TO AVOID SCRATCHING THE CARBON FINISH ON THE CORE.

## Inflating Flitescooter

- 1 Twist the valve cap anti-clockwise to remove.
- 2 To inflate, push the central valve down.
- 3 Twist anti-clockwise to release.
- 4 The valve will pop up. This ensures the bladder will not deflate when you remove the hose after inflation.

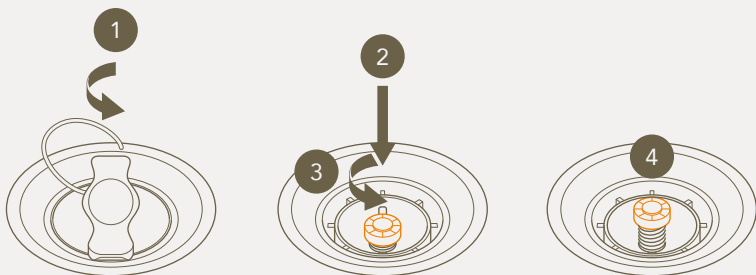

- 5 Connect pump hose to valve and inflate bladder to 15 - 16 PSI.  
THIS IS IMPORTANT FOR OPTIMUM PERFORMANCE AND SAFETY.

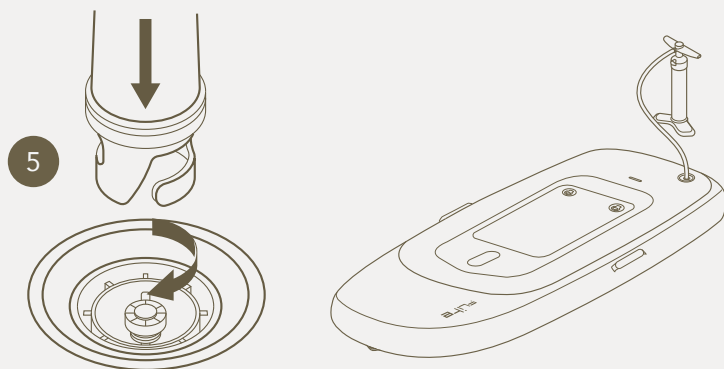

- 6 Once inflated to 15 - 16 PSI, twist the pump hose anti-clockwise to remove and re-fit the valve cover cap. When disconnecting the pump hose, no air should escape from the valve. If the bladder deflates you must release the central valve (see step 2) and re-inflate. Flitescooter is now inflated.

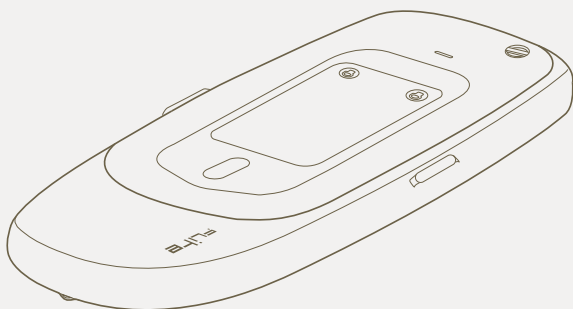

## Connect the eFoil to Flitescooter

- 1 Place the inflated Flitescooter upside down on a clear surface. Locate the Flitebox cavity on the bottom of the board and ensure the 4 retaining screws are removed.
- 2 Check to ensure the orange o-ring is inserted, properly seated in the Flitebox cavity o-ring groove, clean and free of sand, grit or water.
- 3 Carefully lift the eFoil from its bag and place the Flitebox into the cavity. While doing this ensure the power cables feed through into the Flitescooter cavity.
- 4 Ensure the Flitebox is properly seated in the cavity and flush with the board surface.
- 5 Add a thin layer of Tef-Gel to the 4 x 20mm stainless steel hex fasteners. Tighten them in a cross pattern, first using your fingers to ensure the threads are properly engaged, and then using the supplied hex key. Medium force (a torque of 6 Nm) needs to be applied when using the long arm of the hex key to ensure the fasteners are tight.
- 6 When properly tightened, the eFoil should be secured and the o-ring compressed. Failure to properly tighten the fasteners or fit the o-ring will result in a board leak.
- 7 Be careful not to over-tighten the fasteners as this could result in stripped threads or damaged fasteners.

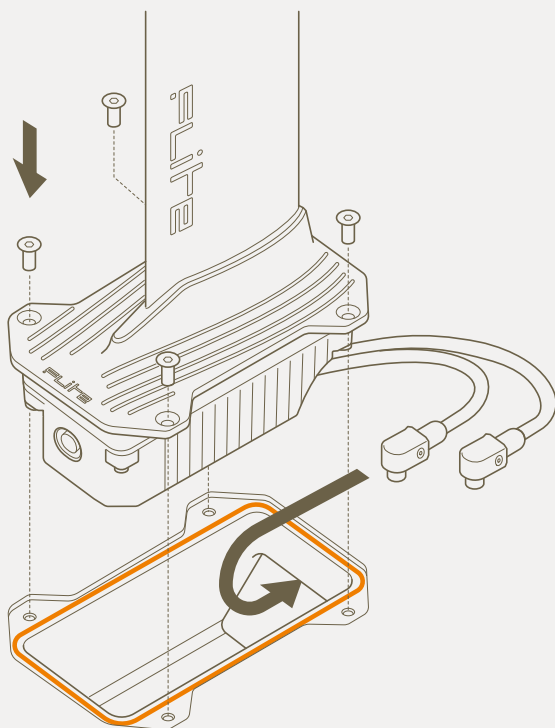

## Installing Flite Jet

Your Flitescooter is supplied with Flite Jet, the recommended propulsion unit for safety and stability. We recommend connecting the eFoil to the Flitescooter first for safer and easier installation of Flite Jet.

- 1 Connect the eFoil to the Flitescooter.
- 2 Check the fuselage thread is clean and free of sand, grit or water.
- 3 Check the Flite Jet thread is clean and free of sand, grit or water. Wipe clean if necessary.
- 4 Apply a small amount of Tef-Gel to the thread of Flite Jet.
- 5 The Dual Drive system uses a reverse thread. Install Flite Jet by rotating ANTI-CLOCKWISE until there is no gap between the jet and fuselage. This should be just finger tight.
- 6 If there is any resistance during installation, remove the Flite Jet completely to check for sand and grit. Try again without using excessive force. Rotate until the gap is closed.
- 7 Pair the Flite Controller and check that 'Jet' is displayed on the Speed / Gear screen. Jet mode adjusts the virtual gears for a better experience when using Flitescooter.

Add a thin layer of Tef-Gel periodically to the threads of the Flite Jet module. For troubleshooting tips, you can visit the Support page on our website.

Fliteboard's Dual Drive system allows you to swap between Flite Jet and the Flite Propeller module with a Pro Tail Cover quickly, without using tools. Please be aware that swapping to Flite Propeller has inherent risks and may be prohibited by local regulations. Where permitted, we recommend that Flite Propeller always be used with the Prop Guard.

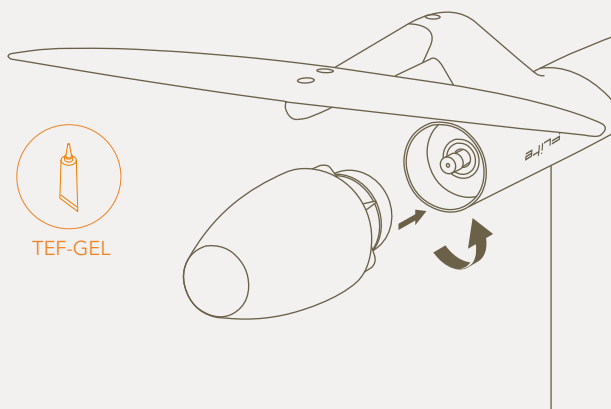

## Connect the fuselage tail

- 1 Place the board upside down with the eFoil connected. Take the fuselage tail from the travel bag, add a light cover of Tef-Gel to the tail connection and install the tail into the fuselage.
- 2 Add a thin layer of Tef-Gel from the tube supplied to the thread of the supplied 16mm fastener bolt and carefully tighten using the hex key using torque of 6 Nm. You may need to push on the tail (compresses the o-ring) for the screw to find the thread. Misalignment may cause damage to the thread.

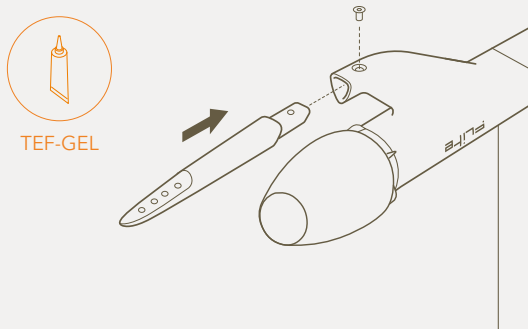

## Connect the wing

- 1 Remove your Cruiser 1800 wing from the travel bag and from its wing cover.
- 2 Place the wing in position as shown. Ensure you have the correct fuselage 1 cover that was provided with your wing (refer to page 12).
- 3 Insert the 3 fasteners taking care to ensure the correct set is being used for the particular wing model you are fitting. ALWAYS add Tef-Gel to the fasteners first. The fasteners should extend by approximately 6-8mm through the wing when placed in the countersunk holes.
- 4 Tighten the fasteners with the supplied hex key, ensuring the fasteners are tight enough that the wing cannot move or wobble significantly during use. Use a torque of 6 Nm to tighten the fasteners.

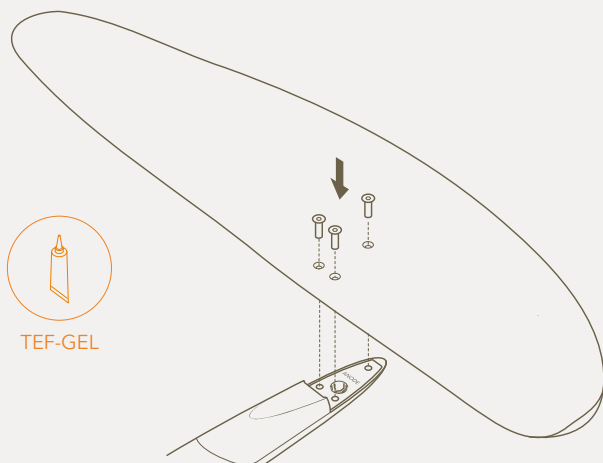



## Connect the stabiliser wing

- 1 Take the Flite 500 stabiliser from the travel bag and remove the wing cover. Make sure to use the provided Flite 500 shims.
- 2 Take the correct stabiliser wing shim and fit between the stabiliser wing and the fuselage tail.
- 3 To ensure correct mounting, direction and placement, the wing when installed correctly should have the rounded, curved leading edge facing the front wing.

ALWAYS ADD TEF-GEL TO THE STAINLESS STEEL FASTENERS THAT ARE BEING INSERTED INTO THE ALUMINIUM. IF LEAVING WINGS ATTACHED FOR EXTENDED PERIODS, ENSURE THAT YOU LOOSEN FASTENERS AND RE-APPLY TEF-GEL EVERY FEW WEEKS. FAILURE TO DO SO MAY RESULT IN CORROSION AND DAMAGE TO YOUR EFOIL FASTENER INSERTS.

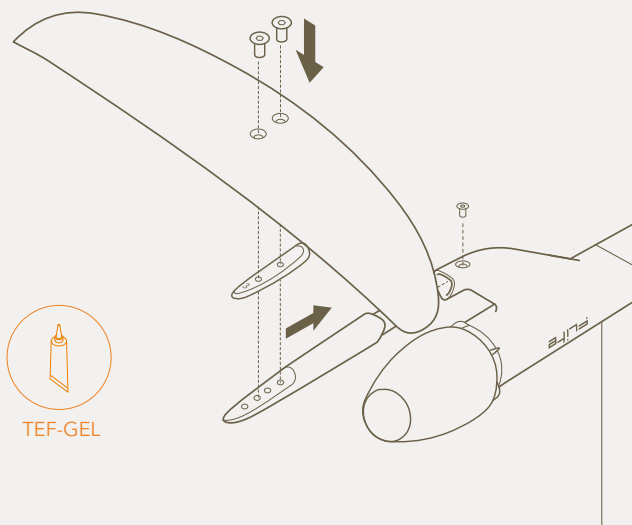

**PRO TIP** We have supplied 0, 1, 2, 3, 4 and 5 degree shims so you can customise your ride. Changing shims alters the amount of stabilising downforce provided by the tail, and also impacts the balance point of the foil and responsiveness. Higher shim numbers can generate earlier takeoff. Based on extensive testing, we recommend using the 3 or 4 shim on Flitescooter.

## Connect Flitecell to Flitescooter

With the eFoil, fuselage tail and wings attached, it's time to carefully turn your board over so it stands on BOTH the front wing and nose of the board.

- 1 Twist the lid latches and open the board lid.

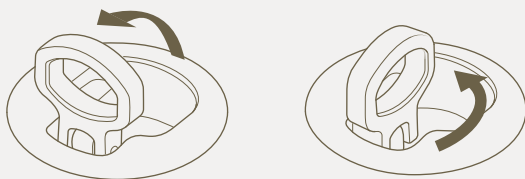

DO NOT OPEN LID WHILST IN THE WATER UNDER ANY CIRCUMSTANCES.

- 2 Take Flitecell by the handle and carefully lower it into the board cavity, ensuring to move cables out of the way first. The warning label should be facing up.

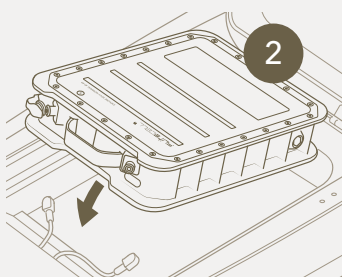

BE CAREFUL NOT TO DAMAGE THE BOARD SEAL WHEN FITTING FLITECELL. ANY KNICKS, CUTS OR DAMAGE TO THE SEAL MAY RESULT IN LEAKS.

BE CAREFUL NOT TO RECONNECT FLITECELL POWER CABLES WITHIN 10 SECONDS OF DISCONNECTION TO AVOID A POSSIBLE ARC.

- 3 If using Flitecell Sport, place the spacer in the board cavity first.
- 4 Connect the orange power cable to the orange power in Flitecell. You will feel a secure click when properly engaged. **Note: Depress the button on the side of the connector when removing the connector.**
- 5 Connect the black power cable to the black power in Flitecell.

**Flitecell is now connected.**

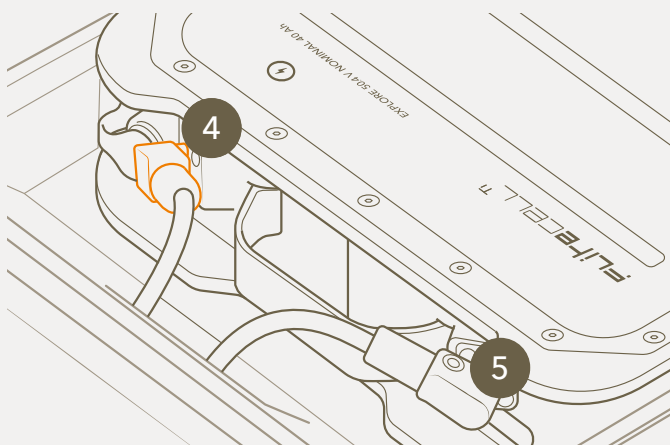

## Download Flite App and update

Flite App is available to download in the Apple App Store™ and Google Play Store™. We recommend using Flite App to ensure your board and Flite Controller always have the latest software to deliver the best performance.

In addition to enhancing your experience on the water, Flite App connects you to a global community of Fliteboard and Flitescooter riders. Share your sessions, compete and discover new places to ride.



Download  
Flite App

[fliteboard.com/app](https://fliteboard.com/app)



Watch our Flite App  
video at

[fliteboard.com/video](https://fliteboard.com/video)

## Flite Controller overview



## Handlebars overview

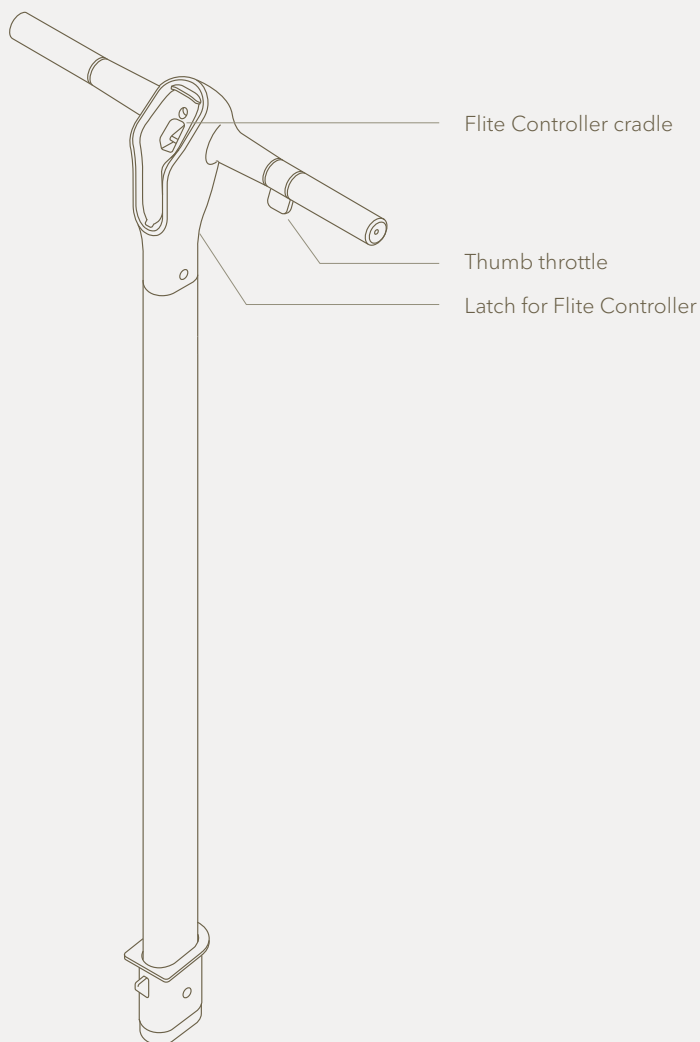

## Turn on Flite Controller

- 1 Turn on Flite Controller by holding down the + button AND Mode (bottom) button together for 3 seconds.
- 2 After a 3 second press of both buttons, the Flite logo will appear with the software version number, and the Controller will move to the home screen with lock icon.

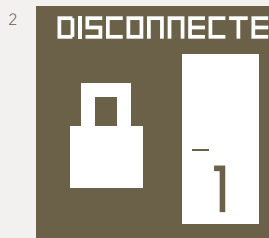
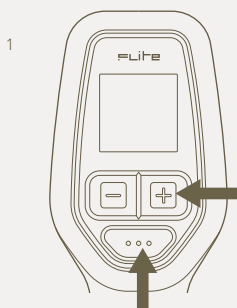

Flite Controller disconnected (requires pairing) and motor locked (requires arming). Gear 1.

Hold + button for 7 seconds to put into pairing mode.

IF THE LED STATUS LIGHT HAS A BLUE SOLID LIGHT (NOT BLINKING) YOUR FLITE CONTROLLER IS CONNECTED.  
IF THE FLITEBOX LIGHT IS FLASHING YOUR CONTROLLER AND FLITESCOOTER NEED TO BE PAIRED.

## Connecting Flite App to Flitescooter

- 1 Turn off Flite Controller.
- 2 Ensure Flitescooter has power and the lid is closed.
- 3 Select **'Flitescooter'** from the **'Devices'** menu. When connected, the board Flitebox LED will turn purple. When performing some updates it will display green.
- 4 You will now be able to see the software version of Flitescooter.
- 5 Once connected you can perform updates and sync session rides.
- 6 Connecting to Flitescooter will transfer settings from the app (e.g. knots and miles per hour).

WHEN NEW SOFTWARE UPDATES ARE AVAILABLE, YOU'LL SEE AN ORANGE UPDATE ICON.

BEFORE YOU UPDATE SOFTWARE MAKE SURE THE PHONE, FLITECELL AND FLITE CONTROLLER HAVE AT LEAST 20% CHARGE.

KEEP THE PHONE CLOSE AND IN LINE OF SIGHT WITH A STRONG WIFI/ CELLULAR NETWORK. DON'T USE THE PHONE FOR ANYTHING ELSE SUCH AS CALLS, TEXTS, OR OTHER APPS.

MAKE SURE THE FLITESCOOTER LID REMAINS CLOSED DURING THE UPDATE PROCESS.

ENSURE FLITE CONTROLLER IS TURNED OFF AS THE APP CAN ONLY CONNECT TO ONE DEVICE AT A TIME.

## Connecting Flite App to Flite Controller

- 1 Turn off Flitescooter.
- 2 Turn on Flite Controller by holding down the + button AND Mode (bottom) button together for 3 seconds.
- 3 Ensure Flite Controller has power and is within range of the phone.
- 4 Select '**Flite Controller**' from the '**Devices**' list. When selected and connected, the current state of charge will be displayed.
- 5 You will now be able to see the software version of the Flite Controller and perform any updates here.

WHEN NEW SOFTWARE UPDATES ARE AVAILABLE, YOU'LL SEE AN ORANGE UPDATE ICON. WHEN UPDATING, DON'T USE THE PHONE FOR ANYTHING ELSE SUCH AS CALLS, TEXTS OR OTHER APPS.

## Capturing sessions

- 1 Flitescooter will automatically capture sessions to its onboard computer.
- 2 Connect to the Flitescooter and then tap '**Sync**' to view and download any new sessions.
- 3 Clicking a ride in the '**Sessions**' list will then take you to ride detail screen. Here you can play back your ride in various speeds, over an aerial map.

## Flite Controller pairing procedure

- 1 Ensure Flitebox power cables are connected to Flitecell. Close the lid and wait for the audible beep indicating the board is switched on.
- 2 Open the Flitescooter lid and place the base of the Flite Controller on the pairing target of the Flitebox (between the Flitecell cables). Note: With the lid open, the system will shut down after 10 seconds.
- 3 Once the LED lights change to scrolling orange, remove the Flite Controller from the pairing target and close the lid.
- 4 Set the controller into pairing mode by holding the + button for 7 seconds until the words '**PRESS MODE TO COMMENCE PAIRING**' appear. Then press mode button to confirm. The words '**LOOKING FOR NEW PAIR**' will appear.
- 5 Once paired successfully, the LEDs will change to a light blue colour.
- 6 Fasten the latches once paired successfully.

Troubleshooting: If the lights are not solid blue, or the battery icon on your Flite Controller is crossed out, this indicates that the Flitecell has not paired, and the process needs to be repeated from Step 1.

The Magnetic Clip can be used to keep Flitecell activated longer than 10 seconds. Remove once paired.

DO NOT HOLD THE FLITE CONTROLLER IN THE PAIRING POSITION FOR MORE THAN 30 SECONDS. HOLDING THE FLITE CONTROLLER IN THIS POSITION WILL PUT THE BOARD INTO SOFTWARE UPDATE.

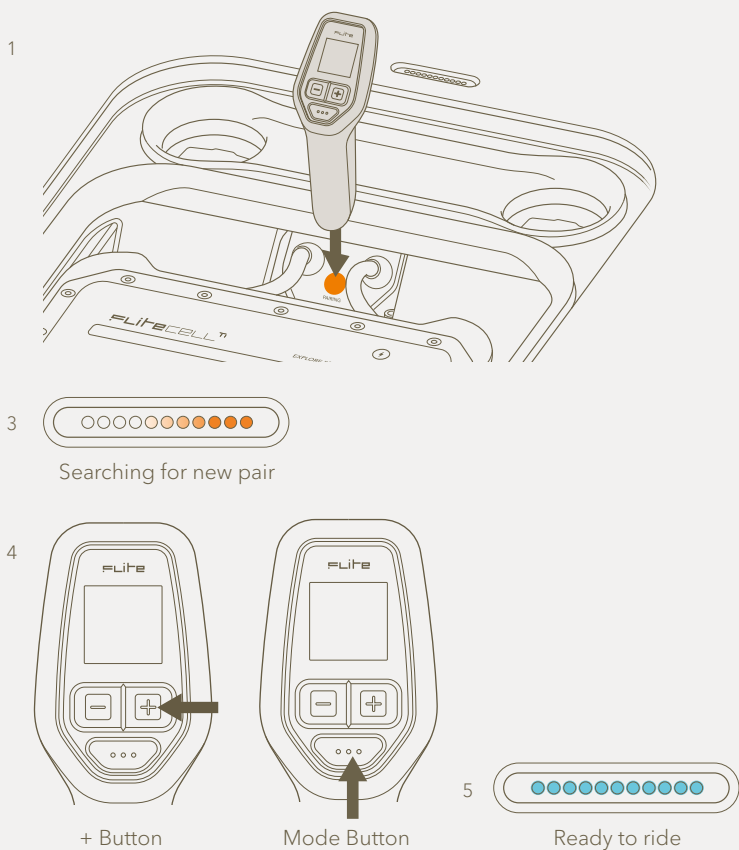



## Flitebox light

## Flite Controller meaning

---

	Light blue solid	Ready to ride
	Red flashing	Alert (high temp, tilt, overcurrent, system error)
	Blue flashing	Armed
	Blue chasing	Motor running
	Orange flashing	Disconnected Flitecell / Controller
	Orange chasing	Searching for new pair Flitecell / Controller
	Purple solid	Flite App connected
	Purple chasing	Flite App data transfer

---

## Flite Controller screen guide

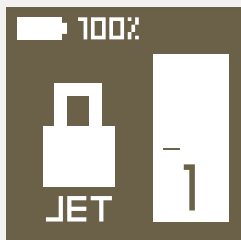

### Motor locked

Ready to arm.  
Flitecell 100% charged  
Gear set to 1  
Jet propulsion selected

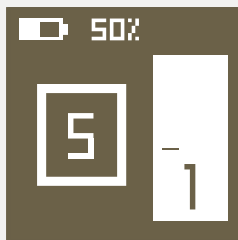

### Motor armed

Motor unlocked with 5 seconds  
to squeeze the throttle trigger.  
Flitecell charge 50%

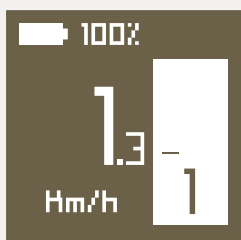

### Current Speed / Gear

Speed 1.3km/h  
Gear 1



### Distance

Travelled 6.4kms  
Remaining 24.7kms  
Current Speed 23.6km/h



### Time

Elapsed 60mins  
Remaining 12mins  
Current speed 23.6km/h



### Speed

Maximum 35.1km/h  
Average 13.2km/h  
Current speed 23.6km/h

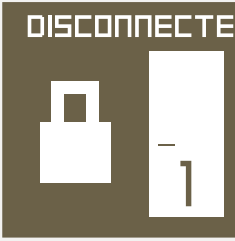

### Disconnected (scrolling)

Flite Controller is not connected or under water. Hold plus for 7 seconds until Flite Controller displays LOOKING FOR NEW PAIR.



### Looking for new pair (scrolling)

Flite Controller is looking for a new pair.

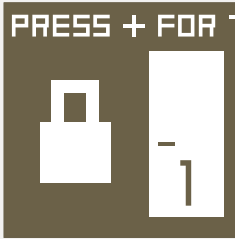

### Pairing required

Flite Controller is not paired. Hold plus for 7 seconds until Flite Controller displays LOOKING FOR NEW PAIR.

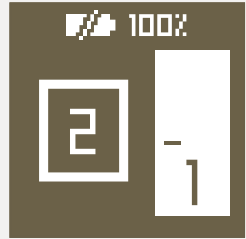

### Battery not paired

Repeat pairing process (see page 32).

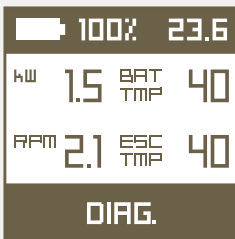

### Diagnostics

Flitecell kilowatts 1.5  
 RPM x 1000 = 2,100  
 ESC Temp 40°C  
 Flitecell Temp 40°C  
 Flitecell Charge 100%  
 Current Speed 23.6km/h



### Efficiency

60 Wh/km  
 Flitecell charge 100%  
 Current speed 23.6km/h

## Flite Controller screen guide



### Charge remaining

Flitecell 98%  
Flite Controller 66%

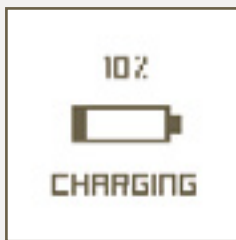

### Flite Controller charging

Flite Controller currently  
at 10% state of charge.



### 50% Flitecell warning

Flitecell has 50% (or less)  
remaining charge.



### Flitescooter tilted

Flitescooter is disabled  
due to the tilt angle.

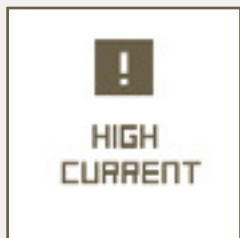

### High Current

Motor Cool Down mode  
will be activated if power  
isn't reduced.

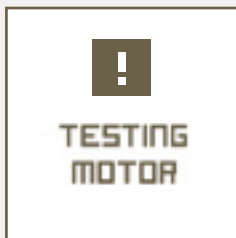

### Testing Motor

To avoid accidental injury,  
this feature prevents  
the motor from being  
turned on fully and any  
overheating to seals, when  
the board is on land.

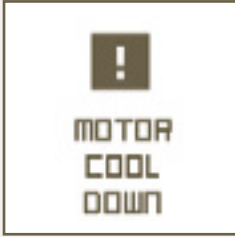

### **Motor Cool Down**

The motor needs to cool down. Flitescooter is limited to low gears for 1 minute to allow motor to cool.



### **High Temp**

Flitecell is too hot. Ride using low power to allow Flitecell to cool, otherwise Flitecell may shut down.



### **Flitecell charge critical**

Flitecell charge very low, immediately return to shore. Flitescooter is limited to low gears only to conserve charge.



### **Flite Controller low charge**

Flite Controller requires charge. Ensure Flite Controller is charged above 50% each ride.

## **Settings**

Flitescooter settings can be updated on the Flite App or the Flite Controller.

To change settings on the Flite Controller, hold the Mode button until the settings screen is displayed.

CONNECTING TO FLITESCOOTER WILL TRANSFER SETTINGS FROM THE APP (E.G. KNOTS AND MILES PER HOUR).

PLEASE BE AWARE THAT SPEED READOUT REQUIRES A GPS CONNECTION. IF YOU ARE RIDING WITH POOR GPS SIGNAL YOU MAY NOT BE ABLE TO SEE YOUR CURRENT SPEED.

## Turning on Flitecell

- 1 Make certain nothing is caught in the seal. Carefully close the lid.
- 2 Twist and lock the two lid latches.
- 3 A few seconds after the lid is shut in position, you will hear a **'beep beep beep'** which signifies that the Flitecell and board have automatically turned on.
- 4 If the external board light is not active, open the lid and ensure the power cables are properly connected, and there are lights on the Flitecell indicating it is switched on.
- 5 Flitecell will automatically turn off 10 seconds after the lid is opened.

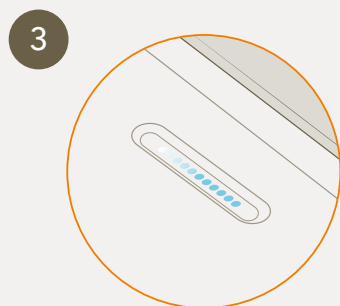
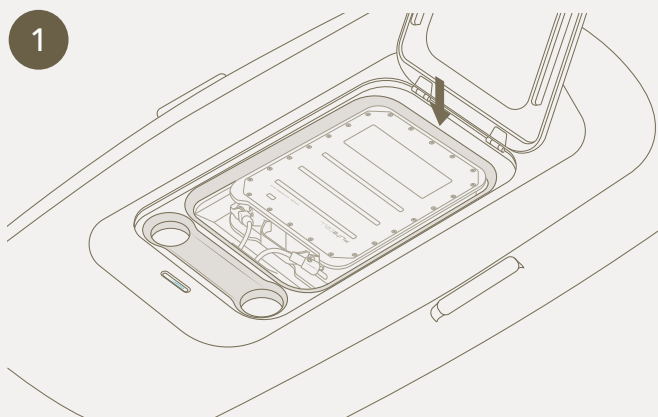

SEE PAGE 32 FOR PAIRING  
FLITE CONTROLLER

THE SEAL IS A CRITICAL COMPONENT. IF DAMAGED CONTACT YOUR FLITE AUTHORISED SERVICE PARTNER FOR A REPLACEMENT PART. NEVER RIDE THE BOARD WITH A DAMAGED SEAL.

THE FLITECELL AND CABLES ARE WATER RESISTANT; HOWEVER, ALWAYS KEEP FLITECELL, CABLES AND BOARD CAVITY DRY. WATER, ESPECIALLY SALT WATER, CAN ACCELERATE AGEING AND CORROSION. IF YOUR BOARD LEAKS, CHECK SEALS, AND CLEAN COMPONENTS CAREFULLY.

## Connect the handlebars to Flitescooter

Flitescooter's excellent buoyancy allows you to step on from a dock or pontoon. If you are starting in the water, do step 2 and 3 from the shore, then float your board with the eFoil facing up to just over waist deep. From there, you can flip your Flitescooter and insert the handlebars.

- 1 Ensure the eFoil is paired to Flite Controller before going in the water.
- 2 Locate the handlebar cap and remove by gently pulling up.
- 3 Turn the handlebars upside down and place the Flite Controller wrist strap over the bottom of the handlebars. Carefully slide the wrist strap to the very top by holding onto Flite Controller.
- 4 With your other hand, lift the latch on the back of the handlebars. Place Flite Controller into the cradle of the handlebars and close the rear latch.
- 5 Turn the handlebar lock counterclockwise so that the opening lines up with the handlebar cavity.
- 6 Check the handlebar cavity is free of sand and grit.
- 7 Insert the handlebars into the handlebar cavity. Turn the handlebar lock clockwise until it stops. This will keep the handlebars locked into place.

2



7

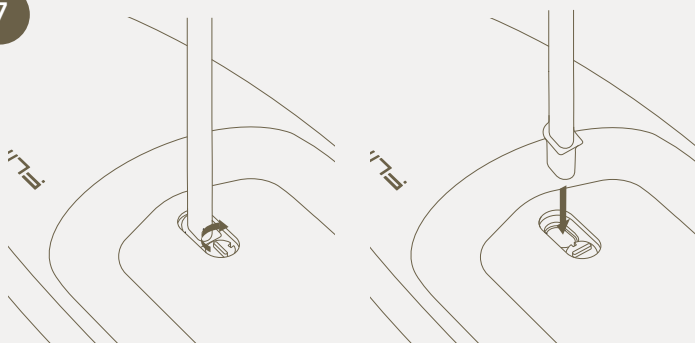

## Flitescooter safety aids

We have implemented the following features to help you have a safe and enjoyable experience on Flitescooter:

- Draw Fly Zones on the app to help avoid shallow water
- Speed limiter which can be changed in the app or Flite Controller
- Wireless safety key to cut off power when you are not on the board

## Select a suitable riding location

A location with a minimum 1 metre / 3.3 feet depth is essential. The wings and eFoil should never make contact with anything below the surface, including a sand bottom. Be aware of tide times, as well as submerged items such as branches, coral, boat chains and fishing lines. If you are unsure about the local area ask someone who knows the waterway for advice.

Choose a location away from swimmers and other water users and ensure local laws allow motorised craft to be used in the area.

Flitescooter should be used in smooth water without waves and currents. It is not designed for use in choppy water.

Flitescooter's excellent buoyancy allows you to step on from a dock or pontoon.

Ride time and range are dependent upon:

- Rider weight
- Average speed
- Water / wind conditions

ENSURING SAFE WATER DEPTH IS EXTREMELY IMPORTANT BEFORE RIDING. SELECT A LOCATION THAT HAS A MINIMUM DEPTH OF AT LEAST 1 METRE / 3.3 FEET.

ALWAYS MONITOR FLITECELL LEVELS WHILE RIDING AND TAKE CARE NOT TO DEplete THE FLITECELL BEFORE RETURNING TO YOUR POINT OF ORIGIN.

NEVER RIDE FLITESCOOTER FURTHER FROM SHORE THAN YOU ARE PREPARED TO SWIM BACK.



Watch our video  
tutorials at  
[fliteboard.com/video](https://fliteboard.com/video)



## Arming the motor

Flitescooter uses a safety lock to guarantee that riders cannot accidentally spin the motor by bumping the throttle trigger unintentionally. Riders must arm (unlock) the motor to take Flite.

- 1 Before arming the motor ensure you are wearing a wireless safety key. The Flitescooter will cut off power when you are not on the board.
- 2 To arm the motor, press the thumb throttle all the way in and then release it completely.
- 3 Press and release the minus button.
- 4 Press the thumb throttle within the 5 second countdown window to activate Flite Jet. Always verify the eFoil is clear and in a safe location before activating the motor.

**IMPORTANT: NEVER RUN THE MOTOR OUT OF WATER FOR MORE THAN 3 SECONDS, AS DOING SO CAN OVERHEAT AND DAMAGE THE SHAFT AND SEALS.**

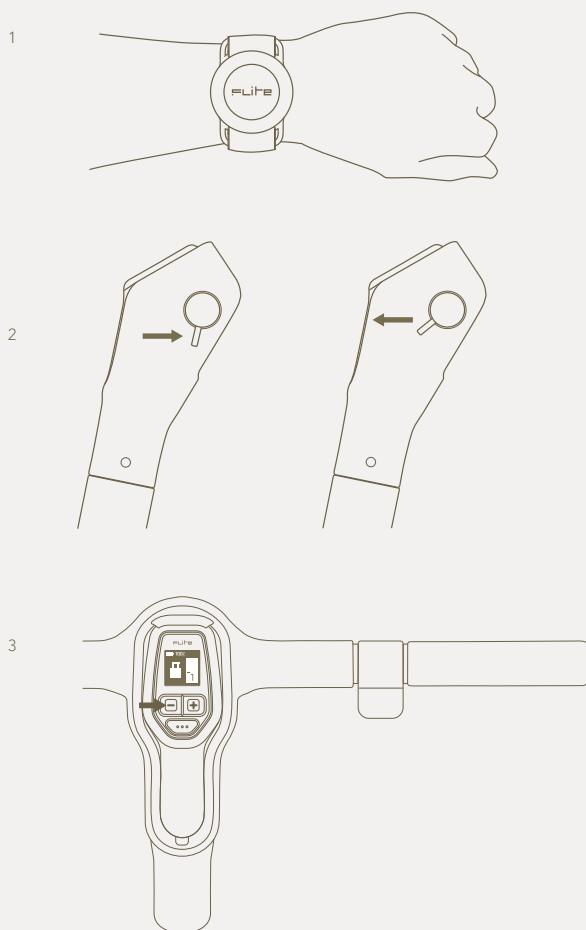

## Riding Flitescooter for the first time

### 1 Wireless safety key

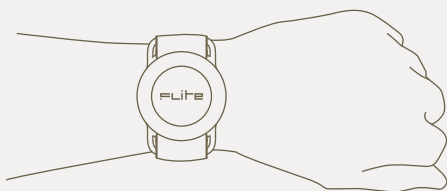

Press the face of the safety key to turn it on. You will now see 'Safety Key Detected' appear on Flite Controller.

### 2 Set 4 points of contact with hands and feet

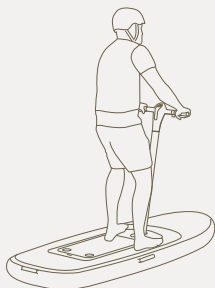

Stand with feet shoulder width apart.

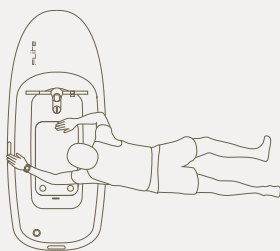

You can simply step onto the Flitescooter from a dock or climb up from the side.

### 3 Check and set your gear

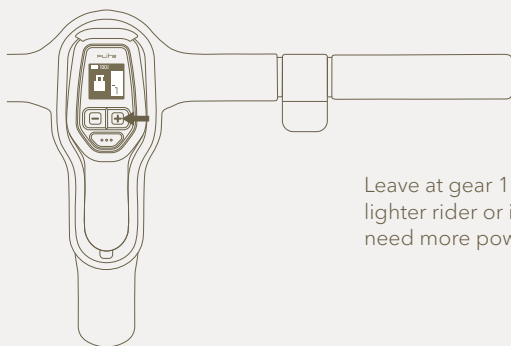

Leave at gear 1 if you are a lighter rider or increase if you need more power.

#### 4 Arm the system



Press the thumb throttle all the way in and then release it completely.

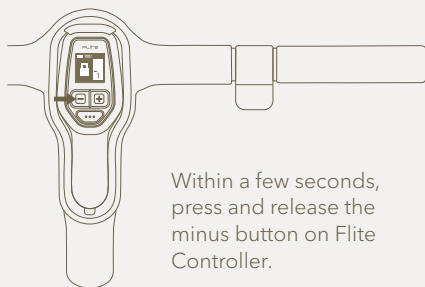

Within a few seconds, press and release the minus button on Flite Controller.

#### 5 Gradually throttle to plane

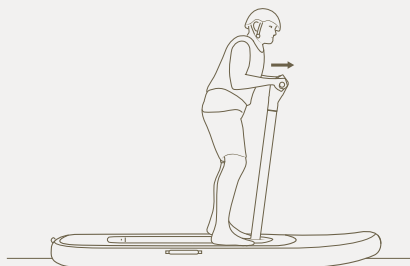

Press the thumb throttle and push forward gently on the handlebars to keep the board flat until planing.

The Flitescooter is planing when it skims over the surface of the water.

#### 6 Lean back to fly

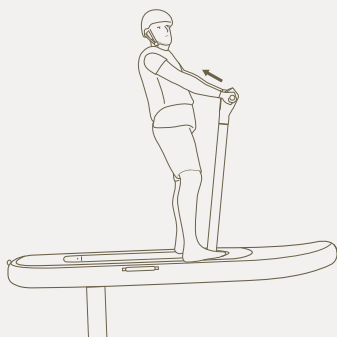

Shift your weight back by softly pulling on the handlebars.

#### 7 Level out

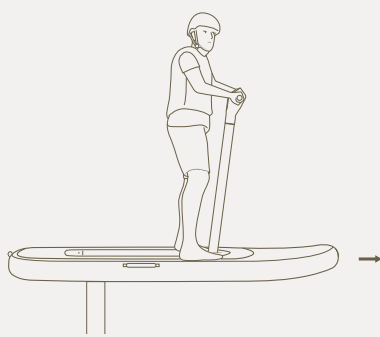

Push forward slightly to level out or touch down. You'll be up and flying in no time.

## Flitescooter common mistakes

Flitescooter rides on wings that fly under water. Just like an airplane, Flitescooter needs sufficient and constant speed to avoid 'stalling' the wings, and must be flown level to avoid changes in altitude (which can cause a wing breach and splashdown). The three most common mistakes riders make when learning to Flitescooter are as follows:

### 1 Taking off with insufficient speed

Pushing or pulling the handlebars changes the angle of the board above the water, and the wings below the water. Pulling back to fly with insufficient speed will 'stall' the wing, causing a splashdown. To avoid this common mistake, continue gently pushing forward on the handlebars (to keep the nose of the board and wing down) until at flying speed. Flying speed is generally 20km/h / 12.5mph or slightly faster for heavier riders.



### 2 Flying too high

Once at sufficient flying speed, riders should take off smoothly by very gently shifting weight back and pulling back on the handlebars. Riders need to angle the nose of the board up a few degrees to take off, but then quickly return board and wing to level position to maintain constant altitude. The skill (and thrill) of Flitescooter is finding the right balance above the water. Pulling or leaning back too hard, or being too aggressive with the handlebars will cause a wing breach or stall, and will result in a splashdown.



### 3 Speed variations

The thrust from Flite Jet is part of the overall balance of the hydrofoil system. Make changes using the thumb throttle smoothly and slowly to maintain smooth and level flight. Varying speed too aggressively can disrupt balance and cause a wing breach, stall or splashdown.

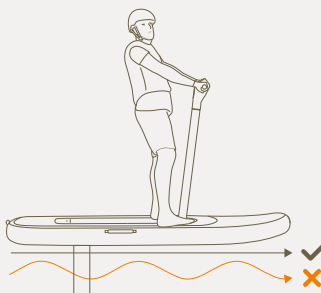

## Flitescooter pro tips

Fly as low as possible when learning and touch down often until confident.

Once foiling, be aware of your weight position to help keep the board level.

If you are taking off too quickly or aggressively, shift feet slightly further forward or change to a lower stabiliser shim number. If you are having to stand too far back to fly (heavier riders) shift to a higher shim number.

If you are having difficulty getting up to speed, increase your starting gear number.

## Foiling through turns

Once comfortable flying in a straight line, you can steer by shifting weight from one foot to the other.

Start by doing very wide turns, using the handlebars to help you turn.

As you gain experience you can try tighter turns.

Keep speed constant through the turn.

**All of this might sound complex, but if you keep your weight forward, fly in flat water, maintain constant speed, and take learning step by step, you will be foiling in no time.**

RAPID RELEASE OF THE TRIGGER CAN CAUSE THE NOSE OF THE BOARD TO SUDDENLY DROP AND MAY CAUSE A CRASH.

## Maintenance and storage

READ THROUGH THE ENTIRE STORAGE AND MAINTENANCE INSTRUCTIONS BEFORE STORING YOUR BOARD.

- 1 It is essential that your Flitescooter be serviced as per the 'Maintenance schedule' at the end of this User Guide to retain its high level of performance, safety and reliability, including warranty, as mentioned previously.
- 2 The service intervals are in hours of ride time or years, whichever comes first.
- 3 The service schedule and intervals assume you will use your Flitescooter in accordance with our guidelines.

## Periodic checks

- 1 Ensure that you view our 'Care and Maintenance video' [fliteboard.com/video](http://fliteboard.com/video) before first using your Flitescooter.
- 2 Ensure that after each session, you visually inspect all elements of your Flitescooter including board, wings, mast, handlebars, Flitecell and Flite Controller for any damage or water ingress.
- 3 Ensure that you perform the 6 Month Flitecell Checklist located on the Support page of the website.
- 4 Ensure all connections are clean, free from corrosion and damage after each use.
- 5 Ensure the hinges have been rinsed with fresh water, are clean and free from corrosion or damage after each use.
- 6 Ensure the handlebars have been rinsed with fresh water, are clean and free from corrosion or damage after each use.

## Maintenance schedule intervals

The hours / years intervals shown in the maintenance schedule section of the User Guide are intended as a guide. If you operate a Fliteschool then supplementary servicing may be necessary.

CAUTION: Avoid leaving your Flitescooter tied up in marinas or near vessels for extended periods of time. Any earth leakage from surrounding vessels can lead to accelerated corrosion of your eFoil components.

Please contact [support@fliteboard.com](mailto:support@fliteboard.com) for any queries or questions.

## Flitescooter

### Post ride

Open the board lid slowly, taking care to not let it fall on the nose of the board or the handlebars.

After each ride, check to see if any water has leaked into the Flitecell cavity.

If so, check the cause of the leak which may include: sand present on the sealing surface; a damaged or dislocated seal; damaged hinges or latches; or something obstructing the lid when closed.

Once the Flitecell has been removed ensure that the complete board, including Flitecell compartment, seals, hinges, lid and eFoil are washed thoroughly in fresh water.

Let the board air dry and then wipe down with a clean, dry absorbent cloth. Ensure that Contact Cleaner is sprayed onto all electrical connections.

### Regular maintenance

Check the carbon core regularly for damage or cracks. If damage is present have it repaired by a professional surfboard or sailboard repairer. The inflatable bladder can be repaired using the supplied repair kit. 15 - 16 PSI is the recommended inflation pressure.

Inspect the orange mast flange seal regularly for any damage and ensure it is kept clean and free of any sand, grit or dirt.

During daily use ensure that the eFoil is removed from the board and wings from the eFoil at least every three days. Ensure Contact Cleaner is applied to all electrical connection points and Tef-Gel is reapplied to all screws.

### Storage

Ensure that all sand, grit, dirt, and salt residue has been washed off with fresh water, and sufficiently dried. Ensure that the Flitecell has been wiped down with a clean, dry absorbent cloth while switched off.

Apply Contact Cleaner to all connectors to reduce the risk of corrosion.

Take care not to scratch the Flitescooter core.

Wash the inflatable bladder with warm soapy water and dry before storage. The inflatable bladder can remain inflated, or be deflated and stored on or off the carbon core to suit your storage preference.

Place your Flitescooter in the provided bag, then store in a clean and dry environment.

Keep the board and bag out of the sun.

## **eFoil system**

### **Post ride**

Disconnect the Flitecell power cables.

Rinse thoroughly with clean fresh water after every use.

Rinse the inside of the mast (through the notch in the rear of the flange) with fresh water.

Rinse around the mast flange to wash salt away from the board connection area (if keeping the board and eFoil attached).

### **Regular maintenance**

Disassemble the eFoil from the board.

Remove the wing, fuselage cover and tail, and clean thoroughly with fresh soapy water to remove any built-up salt or sand.

### **Storage**

Always store the eFoil in a clean, dry environment.

## **Flite Controller and handlebars**

### **Post ride**

Remove the Flite Controller from the handlebars. Rinse the Flite Controller and handlebars with fresh water to clean away salt and debris. Ensure a steady stream of fresh water is applied directly into the trigger housing. While doing so press and depress the trigger and thumb throttle numerous times to loosen any sand, grit or debris that may affect its performance.

Peel out the rubber cover on the underside and clean this with fresh water. Ensure this area is dry before replacing the cover.

### **Regular maintenance**

Pre and post season, the 3 torque screws on the underside of Flite Controller can be undone to release the trigger. This will allow you to thoroughly clean and inspect the trigger, spring and magnet. Regularly check that the Flite Controller trigger and handlebar throttle can move freely.

### **Storage**

Store in a cool dry place, out of the sun.



## Flitecell

### Post ride

Wipe Flitecell down with a wet cloth (freshwater), and clean Flitecell contacts and data connector with Contact Cleaner.

Flitecell is waterproof but it should remain dry where possible. DO NOT submerge or shower.

Avoid placing Flitecell on the sand, which can make its way into the Flitecell cavity and scratch surfaces.

DO NOT charge the Flitecell immediately after use. The Flitecell temperature may be too high. Allow 30 minutes between riding and charging to allow for cooling.

DO NOT clean the Flitecell or charger with denatured alcohol or other flammable solvents.

IF THE BOARD HAS LEAKED AND / OR THE FLITECELL HAS BEEN SUBMERGED IN WATER, INSPECT FOR WATER INGRESS USING THE SIGHT GLASS LOCATED ON THE SIDE OF THE FLITECELL. STAND THE FLITECELL UP ON ITS BOTTOM END FOR ONE MINUTE AND THEN PLACE THE FLITECELL ON ITS SIDE WITH THE SIGHT GLASS FACING DOWN FOR ONE MINUTE. INSIDE THE SIGHT GLASS IS A COLOUR CHANGING LABEL WHICH WILL TURN RED IF WATER IS PRESENT. INSPECT THE SIGHT GLASS AND CONFIRM THAT WATER IS NOT PRESENT BEFORE CHARGING AND USING A FLITECELL THAT HAS BEEN IMMERSSED IN WATER.

IF A FLITECELL HAS BEEN DROPPED OR DAMAGED, CONTACT FLITE IMMEDIATELY AND DO NOT USE THE FLITECELL.

### Regular maintenance

Examine the charger regularly for damage to the cord, plug, enclosure or other parts.

### Storage

Keep Flitecell stored out of the reach of children and pets.

DO NOT store the Flitecell near heat sources such as a furnace or heater. DO NOT leave the Flitecell inside of a vehicle on hot days. The ideal storage temperature is 10°C - 25°C.

Do NOT store the Flitecell whilst charging. Disconnect the charger when not in use.

DO NOT store the Flitecell fully charged or discharged for a longer period of time.

For long or short term storage a charge state of 40% (1 LED ON indicates 25 - 35% charge) is optimal. Only fully charge the Flitecell when planning a ride. We recommend that you discharge the Flitecell during your final session of the season and charge back up to the above state.

## Troubleshooting

Issue	Troubleshooting guide
-------	-----------------------

---

**Flitescooter starts to slow or 'limp'**

This is a sign your Flitecell is about to run down or over heat. Move out of the water and recharge your Flitecell. Refer to the Flitecell charging instructions (page 18).

---

**Flitescooter turns off while riding**

Move out of the water to a safe, dry, clean area. Check the LED on Flitecell to confirm if it still has charge. If it has charge, disconnect and reconnect the Flitecell to see if you can establish a connection. Inspect the Flitecell for water or damage. There should be no water inside the Flitecell housing.

---

**Flite Controller disconnects**

Re-arm the Flite Controller.  
See arming instructions (page 32).

---

**Flite Controller unpairs**

Re-pair the Flite Controller.  
See pairing instructions (page 32).

---

**Flitecell charger won't connect**

Disconnect and reconnect.  
Contact Flitescooter Customer Support.  
[fliteboard.com/support](http://fliteboard.com/support)

---

**Flite Controller won't turn on**

Ensure Flite Controller is fully charged.  
See Flite Controller charging instructions (page 17).

---

**Flite Controller shows a battery or temperature warning**

Slow down or decrease power consumption to cool the Flitecell down. The Flite Controller will warn you when the Flitecell temperature reaches 55°C and again at 60°C. At 65°C the Flitecell will automatically start to shut down to preserve itself.

---

## Issue

## Troubleshooting guide

---

### Flite Controller shows 'Safety Key Not Found'

Flitescooter needs the wireless safety key to operate. Press the face of the wireless safety key to turn it on. If 'Safety Key Detected' does not appear on Flite Controller move away from other Flite Controllers and wireless safety keys and try again. If this persists, replace the coin cell battery within by strictly adhering to the safety warning (page 9).

WIRELESS SAFETY KEY IS ONLY COMPATIBLE WITH FLITESCOOTER.

---

### Flite Controller trigger not functioning

To recalibrate the Flite Controller trigger, press and hold the – (minus) and Mode (bottom) buttons simultaneously. Follow the on-screen instructions.

---

### Water in the Flitescooter cavity

Remove the board from the water. Remove the Flitecell. Dry the board completely. Check the Flitecell for leaks. If the Flitecell has taken in water refer to the section below. Once dried and re-assembled, take care that the Flitescooter cavity seal is properly compressed when closing the Flitescooter lid.

---

### Water in Flitecell

Flitecell has an indicator for water damage. If water has penetrated the casing, regularly check the circular water indicator on the side of your Flitecell. If the sticker has turned red, this means water has penetrated the housing.

IF WATER HAS PENETRATED THE FLITECELL, PLEASE SET FLITECELL ASIDE IN A COOL DRY PLACE. DO NOT ATTEMPT TO USE A FLITECELL THAT HAS BEEN WATERLOGGED. CONTACT FLITE IMMEDIATELY.

---

### Unable to pair Flite Controller

Please ensure no other controllers or boards are switched on. Try again as per pairing instructions (page 32).

---

### Unable to pair Flite Controllers to multiple boards

Do not attempt to pair multiple Flite Controllers to multiple Flitescooters simultaneously. Always pair one at a time.

---

### Reduced ride time

The battery management system (BMS) balances and optimises the Flitecell during each charge cycle. Allow 24 - 48 hours after charging before Flitecell use.

---

## Technical specifications

Load range	RECOMMENDED	WARRANTY LIMIT
Flitescooter with Flite Jet	120kg / 265lbs	120kg / 265lbs

<b>Ride time 85kg rider</b>	Up to 1 hr 30 min (Flitecell Explore) Using a large wing at slow foiling speed, it's possible to ride for over 2 hours.
-----------------------------	---

Board details	KG	LBS	MEASUREMENTS	L
Flitescooter	16	35	2130 L x 880 W x 150mm D (83 <sup>55</sup> / <sub>64</sub> " x 34 <sup>41</sup> / <sub>64</sub> " x 5 <sup>29</sup> / <sub>32</sub> "	237
Handlebars	1.9	4.2	1230 L x 540 W x 110mm D (48 <sup>27</sup> / <sub>64</sub> " x 21 <sup>17</sup> / <sub>64</sub> " x 4 <sup>21</sup> / <sub>64</sub> "	

Travel case	MEASUREMENTS
Flitescooter	1290 L x 640 W x 3450mm D (50 <sup>25</sup> / <sub>32</sub> " x 25 <sup>13</sup> / <sub>64</sub> " x 13 <sup>25</sup> / <sub>64</sub> "
eFoil case	1100 L x 640 W x 260mm D (3'8" x 2'2" x 10")
Flitecell travel bag	450 L x 370 W x 90mm D (5'3" x 2'3" x 3' <sup>5</sup> / <sub>8</sub> "

## Flitescooter core

<b>Materials</b>	Carbon fibre, Innegra, fibreglass, aircraft grade aluminium, high quality wood laminates and composites.
------------------	--

## Flitescooter materials

<b>Type</b>	Inflatable
<b>Materials</b>	Selytech Composite Super Light Drop Stitch Fabric / PVC / EVA
<b>Pressure</b>	15 - 16 PSI

## Flite eFoil system

Input power	5,000 Watts
Max output power at shaft	3,600 Watts
Nominal voltage	52V
Maximum current	100A
Motor type	Brushless
Motor speed	4500 rpm peak
Protections	Overheating, overcurrent
Flite Jet diameter	90mm

## Flite Controller

Communication type	Bluetooth
Speed control	20 virtual gears
Runtime	Average charge 24 hrs / Standby 200 hrs
Rated cycles	1000 charge cycles
Protection grade	IP67

## Flitecell Fast Charger

Charging current	25A
Charge time	1 hr 45min Flitecell Explore 1 hr 15min Flitecell Sport

## Flitecell Charger

Charging current	13.5A
Charge time	2hr 30min Flitecell Explore 1 hr 45min Flitecell Sport

## Flitecell Explore

<b>Size</b>	390mm x 305mm x 80mm (15" x 12" x 13")
<b>Capacity</b>	40Ah / 2016Wh
<b>Weight</b>	14.5kg / 32lbs
<b>Protection</b>	IP67
<b>Max charge voltage</b>	58.8V
<b>Min voltage</b>	42V
<b>Nominal voltage</b>	50.4V
<b>Rated continuous discharge current</b>	100A
<b>Rated charge current</b>	25A
<b>Rated cycles &gt;80% capacity</b>	400 Cycles
<b>Temperature discharge limits</b>	0 - 70 Degrees C 32 - 158 Degrees F
<b>Temperature charge limits</b>	0 - 50 Degrees C 32 - 122 Degrees F
<b>Communication</b>	Bluetooth Low Energy
<b>BMS critical functions</b>	Balancing, Over-temperature (Charge / Discharge) Over-current, short-circuit protection, reverse polarity and over & under voltage.
<b>Other safety</b>	3 levels of fusing adds redundancy if BMS failure occurs. Conformal / resin coatings used on PCB's.  Phase Changing Material between cells and sight glass to check for leaks.
<b>Shipping and transport</b>	Flitecell (batteries) are considered a dangerous good and must not be shipped without working with a dangerous goods shipping specialist.  Shipping batteries marked as normal goods without informing the shipping party is illegal and dangerous. The Material Safety Data Sheet (MSDS) is required for shipping the batteries.

## Flitecell Sport

<b>Size</b>	305mm x 305mm x 80mm (12" x 12" x 13")
<b>Capacity</b>	29.4Ah / 1487Wh
<b>Weight</b>	10.6kg / 23.4lbs
<b>Protection</b>	IP67
<b>Max charge voltage</b>	58.8V
<b>Min voltage</b>	42V
<b>Nominal voltage</b>	50.4V
<b>Rated continuous discharge current</b>	100A
<b>Rated charge current</b>	25A
<b>Rated cycles &gt;80% capacity</b>	400 Cycles
<b>Temperature discharge limits</b>	0 - 70 Degrees C 32 - 158 Degrees F
<b>Temperature charge limits</b>	0 - 50 Degrees C 32 - 122 Degrees F
<b>Communication</b>	Bluetooth Low Energy
<b>BMS critical functions</b>	Balancing, Over-temperature (Charge/Discharge) Over-current, short-circuit protection, reverse polarity and over & under voltage.
<b>Other safety</b>	3 levels of fusing adds redundancy if BMS failure occurs. Conformal / Resin coatings used on PCB's.  Phase Changing Material between cells and sight glass to check for leaks.
<b>Shipping and transport</b>	Flitecell (batteries) are considered a dangerous good and must not be shipped without working with a dangerous goods shipping specialist.  Shipping batteries marked as normal goods without informing the shipping party is illegal and dangerous. The Material Safety Data Sheet (MSDS) is required for shipping the batteries.

## Warranty registration / Details of purchase

Customer name

---

Business name  
(if applicable)

---

Country & State

---

Purchased from

---

Date of purchase

---

Board type & serial number

---

eFoil  60cm

---

Propulsion  Flite Jet

---

Flitecell type  Explore  Sport

---

eFoil serial number

---

Flitecell serial number(s)

---

Flite Controller serial number(s)

---

Flitecell Charger type & serial number

---



## Maintenance schedule

### FIRST 100 HOURS / 1 YEAR SERVICE

#### Inspected

Mast

Fuselage

Flitebox

Cables

Handlebars

Flite Jet

Flitecell health

Wireless safety key

Flite Controller

#### Replaced

Seals

Oil

Flitebox Gore vent

Cables

Handlebars

Flite Jet

Anode

Safety key coin cell

Flite Controller

#### Comments

eFoil Hours of use

Date

Name of Technician

Signature of Technician

Authorised Service Partner

## Maintenance schedule

### 200 HOURS / 2 YEAR SERVICE

WHICHEVER COMES FIRST

#### Inspected

Mast

Fuselage

Flitebox

Cables

Handlebars

Flite Jet

Flitecell health

Wireless safety key

Flite Controller

#### Replaced

Seals

Oil

Flitebox Gore vent

Cables

Handlebars

Flite Jet

Anode

Safety key coin cell

Flite Controller

#### Comments

eFoil Hours of use

Date

Name of Technician

Signature of Technician

Authorised Service Partner

## Maintenance schedule

### 300 HOURS / 3 YEAR SERVICE

WHICHEVER COMES FIRST

#### Inspected

Mast

Fuselage

Flitebox

Cables

Handlebars

Flite Jet

Flitecell health

Wireless safety key

Flite Controller

#### Replaced

Seals

Oil

Flitebox Gore vent

Cables

Handlebars

Flite Jet

Anode

Safety key coin cell

Flite Controller

#### Comments

---

---

eFoil Hours of use

Date

---

Name of Technician

---

Signature of Technician

---

Authorised Service Partner

---

## Maintenance schedule

### 400 HOURS / 4 YEAR SERVICE

WHICHEVER COMES FIRST

#### Inspected

Mast

Fuselage

Flitebox

Cables

Handlebars

Flite Jet

Flitecell health

Wireless safety key

Flite Controller

#### Replaced

Seals

Oil

Flitebox Gore vent

Cables

Handlebars

Flite Jet

Anode

Safety key coin cell

Flite Controller

#### Comments

eFoil Hours of use

Date

Name of Technician

Signature of Technician

Authorised Service Partner

## Maintenance schedule

### 500 HOURS / 5 YEAR SERVICE

WHICHEVER COMES FIRST

#### Inspected

Mast

Fuselage

Flitebox

Cables

Handlebars

Flite Jet

Flitecell health

Wireless safety key

Flite Controller

#### Replaced

Seals

Oil

Flitebox Gore vent

Cables

Handlebars

Flite Jet

Anode

Safety key coin cell

Flite Controller

#### Comments

---

---

eFoil Hours of use

Date

---

Name of Technician

---

Signature of Technician

---

Authorised Service Partner

---

**Congratulations on becoming  
a Flitescooter owner.**

Now it's time to get out there and  
experience the freedom of Flite.



